

# CNA-CNB CENTRIFUGAL FANS STANDARD TEMPERATURES AND EX



# PRODUCT FACTS

## PRODUCT

The centrifugal fans type CNA and CNB are robust and versatile fans of the single-inlet type with backward-curved blades.

## APPLICATION

In industrial ventilation systems for uncontaminated, non-corrosive air, max. 70 °C, where a low sound level is required. The M-types are for corrosive environments. Versions for marine EX applications are also available.

## RANGE

**CNA:** 9 installation sizes with impeller diameters from 250-1000 mm. Airflow rates from 0.2-14 m<sup>3</sup>/s and pressures up to 1000 Pa.

**CNB:** 7 installation sizes with impeller diameters from 400-1000 mm. Airflow rates from 0.8-18 m<sup>3</sup>/s and pressures up to 1500 Pa.

Part of the range is available as standard configurations in the Standard Range. The range comprises 10 fixed size-motor combinations.

## CONSTRUCTION

Fan housing with rectangular side panels for universal installation. The housing is rotatable in 90° steps. The fans are available in direct driven and belt-driven versions.

## MOTORS

**Mounting:** On base frame or on fan casing, depending on drive type and motor size

**Terminal boxes:** Part of motor housing

**Dimension standard:** IEC-72

**Electrical standard:** IEC-34

**Enclosure:** IP55, IP56 or IP65

**Insulation:** Class F

**Structural shape:** B3 and B14 for flanges

## MATERIALS

**Housing, CNA-CNB (standard and marine EX):** Sendzimir galvanised (hot-dip galvanised) sheet steel, unpainted

**Housing, CNA-M and CNB-M:**

Sendzimir galvanised sheet steel with epoxy coating or aluzink

**Impeller, CNA 250 to 630 (standard and marine EX):**

Spot-welded, galvanised sheet steel, unpainted

**Impeller, CNA 710 to 1000 (standard and marine EX):**

Welded Corten sheet steel

**Impeller, CNA-M 250 to 630:**

Spot-welded, galvanised sheet steel, unpainted

**Impeller, CNA-M 710 to 1000:**

Welded Corten sheet steel

**Impeller, CNB and CNB-M:**

Welded Corten sheet steel, hot-dip galvanised

**Inlet cone, CNA-CNB 250 to 630:**

Galvanised deepdrawn sheet, unpainted

**Inlet cone, CNA-CNB 710 to 1000:**

Cast aluminium, unpainted

## CLASSIFICATIONS

The fans meet the requirements for operation in unheated, low corrosion environments and are CE-certified.

**Environment:** DS/EN 12944-2, corrosion category C2

**Technical capacity:** BS 848:1980 and ISO 5801:1997, installation type D

**Temperature range, standard:**

-20 to 50 °C

**Temperature range, max.:**

-20 to 70 °C

**Marine motor classification:** Refer to AirBox program for available registers

**Marine EX:** Guidelines IACS F29/2005

**Calculation software:**

AirBox program is certified by TÜV.

## ACCESSORIES

### Installation

- Flexible connections
- Counter flange for outlet
- Duct spigots for inlet
- Anti-vibration mountings
- Common base frame (fan and motor)
- Suction box

### Regulation

- Infinitely variable regulator (CNA 250 and 315 single-phase direct driven motor)
- 3-stage regulator (CNA 250 and 315 single-phase direct driven motor)
- 2-speed motor, 3-phase
- Frequency inverter, 3-phase motors

### Protection

- Guard net (inlet and outlet)
- Inlet cone of brass (marine EX)
- Epoxy coating (CNA)

### Service

- Inspection and access doors
- Drain plug

# DESCRIPTION

Centrifugal fans of type CNA and CNB are light, compact low pressure fans, designed for universal installation in light industrial plants.

Type CNA is produced in 9 sizes with impeller diameters from 250-1000 mm, airflow rates from 0.2-14 m<sup>3</sup>/s and total pressures up to approximately 1000 Pa.

Type CNB is produced in 7 sizes with impeller diameters from 400-1000 mm and is designed for higher RPMs with airflow rates from 0.8-18 m<sup>3</sup>/s and total pressures up to 1500 Pa.

Centrifugal fans of type CNA and CNB consist of the following main components.

- Fan housing, constructed from two rectangular side panels and a casing.
- Inlet cone, mounted in the fan front side panel with a boss for duct connection and designed so that the air is conducted without loss to the impeller.
- Impeller with wide, backward curved blades.

## BELT DRIVE

A bearing part with two dust and waterproof encapsulated deep groove ball bearings in a flanged bearing housing, mounted on the rear side panel of the fan, or two flanged bearings mounted in two covers. The bearing part in CNB 500 to -1000 must be relubricated. Other sizes have lifetime lubrication.

## SURFACE TREATMENT

All fan parts are protected against standard corrosive action.

## ACCESSORIES

**Motor** according to specifications

**Motor panel** for installing motors up to the sizes stated on page 7 on the fan

housing flanges. The motor panel can be adjusted to tighten the belts.

**Belt drive**, consisting of pulleys, V-belts and belt guards

**Flexible connections** for the inlet boss and outlet flange

**Counter flange** for the outlet flange

**Duct spigot** for installation on the fan inlet boss. The inlet flange is also used to connect a flexible connection to the inlet guide vane arrangement.

**Anti-vibration mountings** for fitting between fan or base frame and foundation

**Common base frame** for installing motors over the sizes stated on page 6 beside the fan.

Sizes -250, -315 and -400 are also available with a direct driven flanged motor installed on the fan rear side panel.

Sizes -500 and -630 are also available with a direct driven base motor installed on a motor bracket.

**Suction box** for outlet and universal connection to duct system

**Guard net** for the inlet opening

**Inlet cone of brass** for marine EX.

**Epoxy coating (CNA)** in any colour

**Inspection hatch** placed in the casing of the fan housing

**Drain plug**, see page 7.

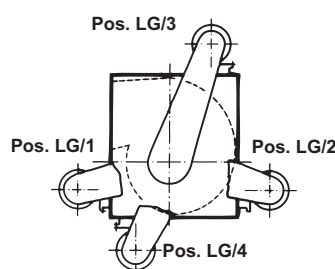
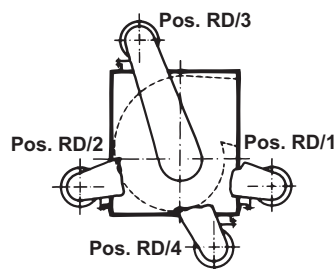

## SCROLL POSITIONS

Direction of rotation RD or LG. Motor positions 1, 2, 3 and 4 indicate the position of the motor in relation to the outlet opening.

## MARINE EX APPLICATIONS

The complete range of CNA and CNB is available as marine EX fans that follow the guidelines in IACS F29/2005 for non-sparking fans. The fans have brass inlet cones and are well-suited for transport of air containing flammable gases.

## AIRBOX CALCULATION PROGRAM

The AirBox program is Novenco's calculation and configuration tool. Input to the program are requirements for airflow and pressure as well as specific characteristics of the operating environment. Further requirements for the fan, motor and accessories are also input and form the basis for calculation of possible solutions.

Novenco AirBox is free and available on [www.novenco-building.com](http://www.novenco-building.com). It is certified by TÜV Süd in Germany, requires registration and checks automatically for updates.

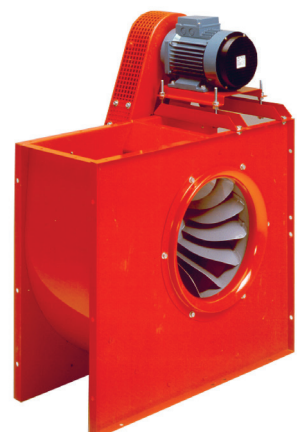

# STANDARD RANGE

The composition of the Standard Range is based on sales statistics. It represents the most commonly sold fan sizes and requested performances.

The range covers 10 pre-configured CNA fan configurations. These standards have lower prices and shorter delivery times compared to custom configurations. Accessories are available on the same terms as for custom configurations.

Fans in the Standard Range operate in the temperature area between -20 and 50 °C. The standardisation comprises impeller diameters, rotation directions, motors and other constructional parameters. The motors are all direct

driven and the inlets and outlets are to ducts.

All Standard Range fans are available in AirBox and calculate the same way as the custom configurations. The standard configurations in AirBox block for modifications, which means that accessories are ordered separately and not from within AirBox.

Item no.	Fan size [mm]	Rotational direction <sup>1</sup>	Airflow [m <sup>3</sup> /s]	Airflow [m <sup>3</sup> /h]	Total pressure [Pa]	Static pressure [Pa]	Power input [kW]	Fan RPM	Fan max. RPM
30044121	Ø250	Left	0.50	1800	483	404	0.455	2282	3600
30044122		Right							
30044123		Left	0.70	2520	1000	846	1.208	3263	3600
30044124		Right							
30044125	Ø315	Left	0.42	1512	500	478	0.426	1736	3000
30044126		Right							
30044127		Left	0.70	2520	1000	939	1.205	2454	3000
30044128		Right							
30044129	Ø400	Left	0.80	2880	823	792	1.204	1724	1950
30044130		Right							

## DATA FOR STANDARD RANGE FANS AT SELECTED CONDITIONS

1. The rotational direction is from the motor side.

# PERFORMANCE CURVES

The basis for dimensioning is the air-flow rate and the pressure loss in the ventilation system in question = the fan static pressure,  $p_s = p_{s2} - p_{s1}$ . To establish the fan total pressure  $p_t$ , add the air speed pressure, the dynamic pressure  $p_d$  at the outlet and the installation loss at the inlet  $p_1$  and outlet  $p_2$ . These values are stated in connection with the dimensioning graphs on pages 9 to 13. All graphs are plotted for arrangement D.

## CHOICE OF MOTOR

The power consumption in the dimensioning graphs refers to the fan shaft. To cover the loss in the belt drive, bearing parts and more, the power consumption reading is increased by factor  $C_1$ .

$C_1$  depends on the fan size.

315-630 :  $C_1 = 1.2$

710-1000 :  $C_1 = 1.1$

## DIMENSIONING EXAMPLE

### Arrangement D

Duct for the inlet and outlet

Airflow rate  $q_v = 1.75 \text{ m}^3/\text{s}$ .

$p_{s2} - p_{s1} = 1300 \text{ Pa}$

The graph on page 11 shows that type CNB 400 is best suited.

The graph shows the following:

Fan speed: 2300 RPM

Efficiency: 72%

Power demand: 3.5 kW

Correction:  $2.3 \times 1.2 = 4.2 \text{ kW}$

Choice of motor: 5.5 kW

$p_{s2} - p_{s1}$	=	1300 Pa
+ $p_d$	=	155 Pa
Total pressure	=	1455 Pa

### ARRANGEMENT A

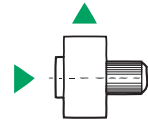

$P_{s2} - P_{s1}$	=	Pa
+ $p_1$	=	Pa
+ $p_d + P_2$	=	Pa
Total pressure	=	Pa

### ARRANGEMENT C

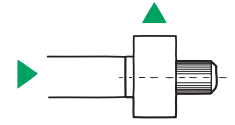

$P_{s2} - P_{s1}$	=	Pa
+ $p_d + P_2$	=	Pa
Total pressure	=	Pa

### ARRANGEMENT B

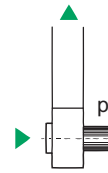

$P_{s2} - P_{s1}$	=	Pa
+ $P_1$	=	Pa
+ $p_d$	=	Pa
Total pressure	=	Pa

### ARRANGEMENT D

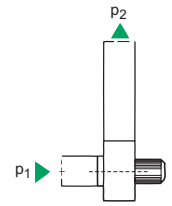

$P_{s2} - P_{s1}$	=	Pa
+ $p_d$	=	Pa
Total pressure	=	Pa

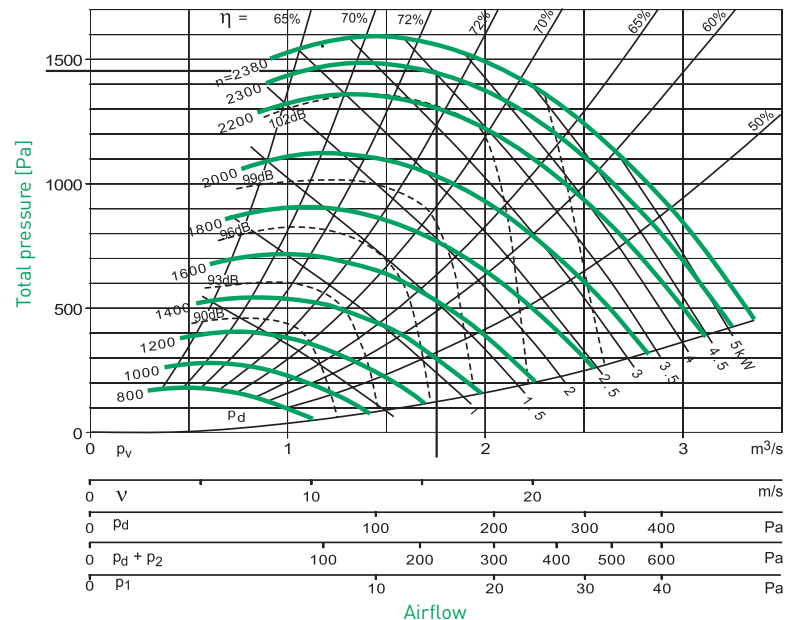



### CNA 250

Max. = 3150 RPM (belt-driven)  
 Max. = 3600 RPM (direct driven)  
 $\rho = 1.20 \text{ kg/m}^3$   
 $l_v = 0.025 \text{ kgm}^2$

### CIRCUMFERENTIAL SPEED

$u = 0.013 \times n, \text{ m/s}$

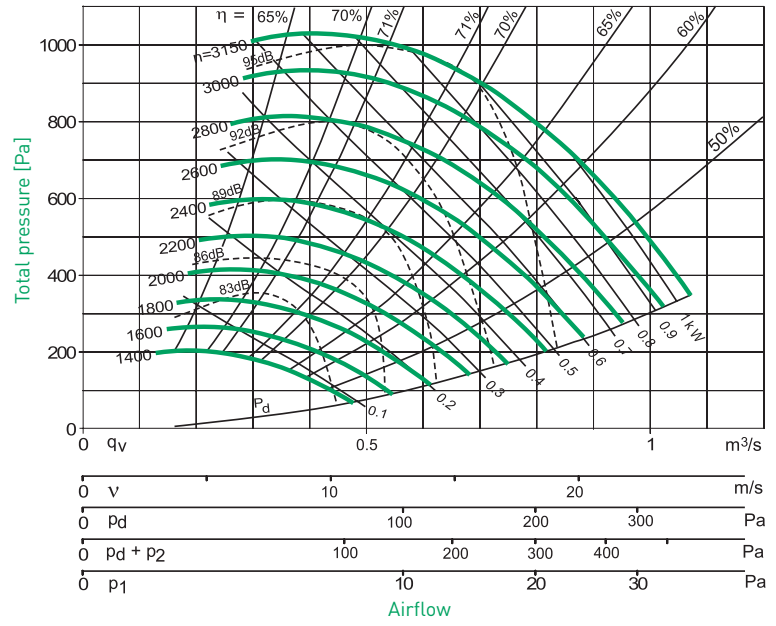

### CNA 315

Max. = 3000 RPM  
 $\rho = 1.20 \text{ kg/m}^3$   
 $l_v = 0.05 \text{ kgm}^2$

### CIRCUMFERENTIAL SPEED

$u = 0.016 \times n, \text{ m/s}$

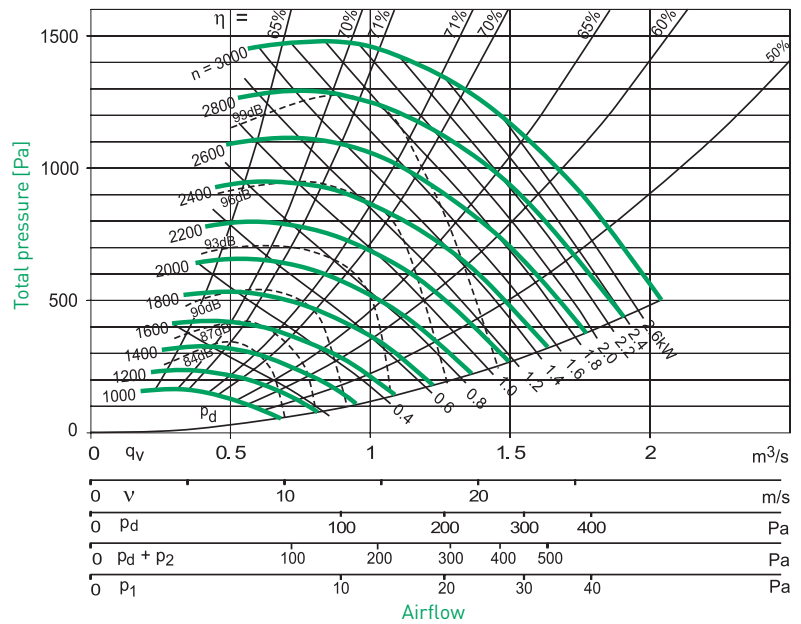

### BASIS FOR CHART

(Arr. D)

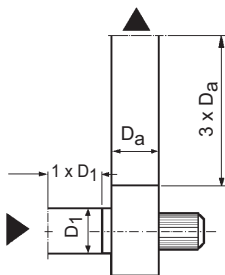

### SYMBOLS

- |       |                            |        |                             |
|-------|----------------------------|--------|-----------------------------|
| $p_t$ | = total pressure           | $q_v$  | = airflow                   |
| $p_d$ | = dynamic pressure, outlet | $n$    | = RPM                       |
| $p_1$ | = connection loss, inlet   | $\eta$ | = efficiency in %           |
| $p_2$ | = connection loss, outlet  | kW     | = power demand, impeller    |
| $v$   | = air speed, outlet        | dB     | = sound power level, outlet |

**CNA 400**

max. = 1950 RPM  
 $\rho = 1.20 \text{ kg/m}^3$   
 $l_v = 0.175 \text{ kgm}^2$

**CNB 400**

max. = 2380 RPM  
 $\rho = 1.20 \text{ kg/m}^3$   
 $l_v = 0.3 \text{ kgm}^2$

**CIRCUMFERENTIAL SPEED**

$u = 0.021 \times n, \text{ m/s}$

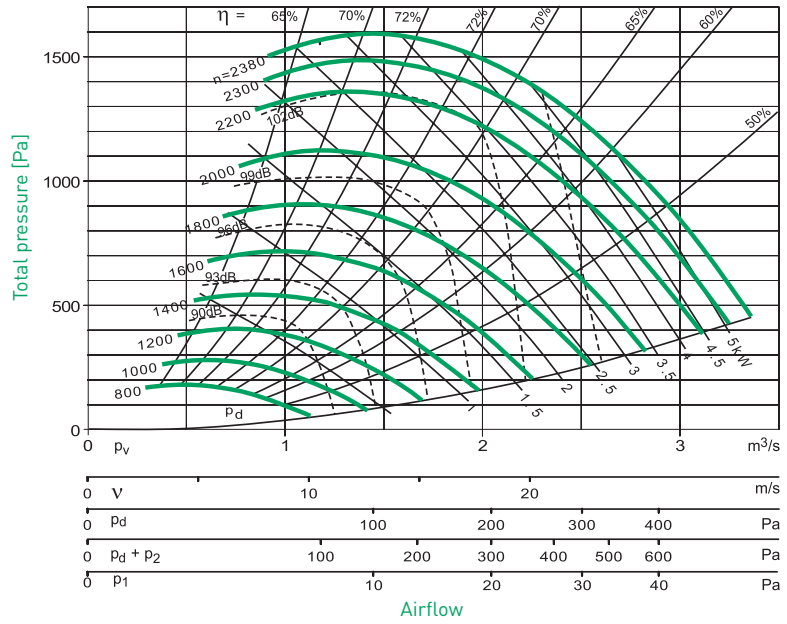

**CNA 500**

max. = 1575 RPM  
 $\rho = 1.20 \text{ kg/m}^3$   
 $l_v = 0.55 \text{ kgm}^2$

**CNB 500**

max. = 1925 RPM  
 $\rho = 1.20 \text{ kg/m}^3$   
 $l_v = 0.75 \text{ kgm}^2$

**CIRCUMFERENTIAL SPEED**

$u = 0.026 \times n, \text{ m/s}$

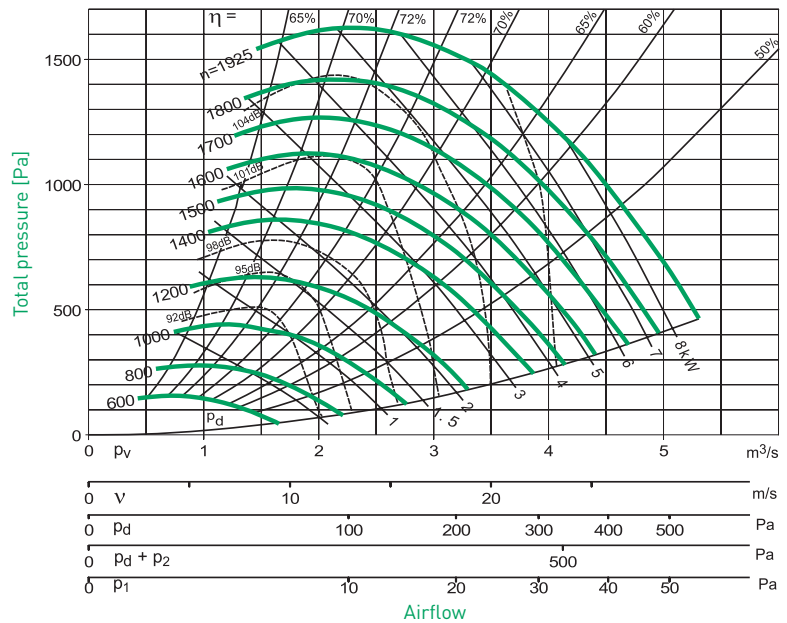

**BASIS FOR CHART**

(Arr. D)

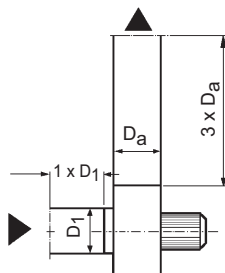

**SYMBOLS**

- |       |                            |        |                             |
|-------|----------------------------|--------|-----------------------------|
| $p_t$ | = total pressure           | $q_v$  | = airflow                   |
| $p_d$ | = dynamic pressure, outlet | $n$    | = RPM                       |
| $p_1$ | = connection loss, inlet   | $\eta$ | = efficiency in %           |
| $p_2$ | = connection loss, outlet  | $kW$   | = power demand, impeller    |
| $v$   | = air speed, outlet        | $dB$   | = sound power level, outlet |

### CNA 630

max. = 1240 RPM  
 $\rho = 1.20 \text{ kg/m}^3$   
 $I_v = 1.35 \text{ kgm}^2$

### CNB 630

max. = 1515 RPM  
 $\rho = 1.20 \text{ kg/m}^3$   
 $I_v = 1.85 \text{ kgm}^2$

### CIRCUMFERENTIAL SPEED

$u = 0.033 \times n, \text{ m/s}$

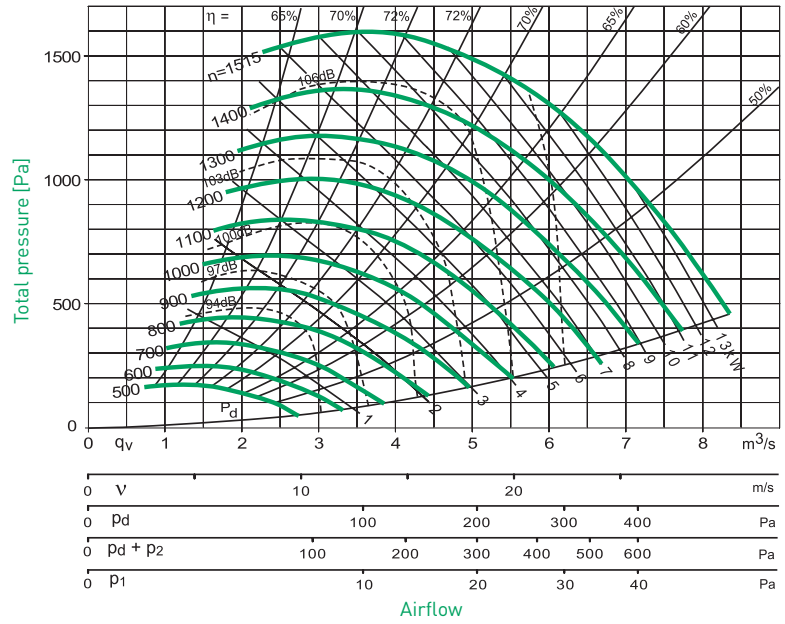

### CNA 710

max. = 1105 RPM  
 $\rho = 1.20 \text{ kg/m}^3$   
 $I_v = 3 \text{ kgm}^2$

### CNB 710

max. = 1350 RPM  
 $\rho = 1.20 \text{ kg/m}^3$   
 $I_v = 3 \text{ kgm}^2$

### CIRCUMFERENTIAL SPEED

$u = 0.037 \times n, \text{ m/s}$

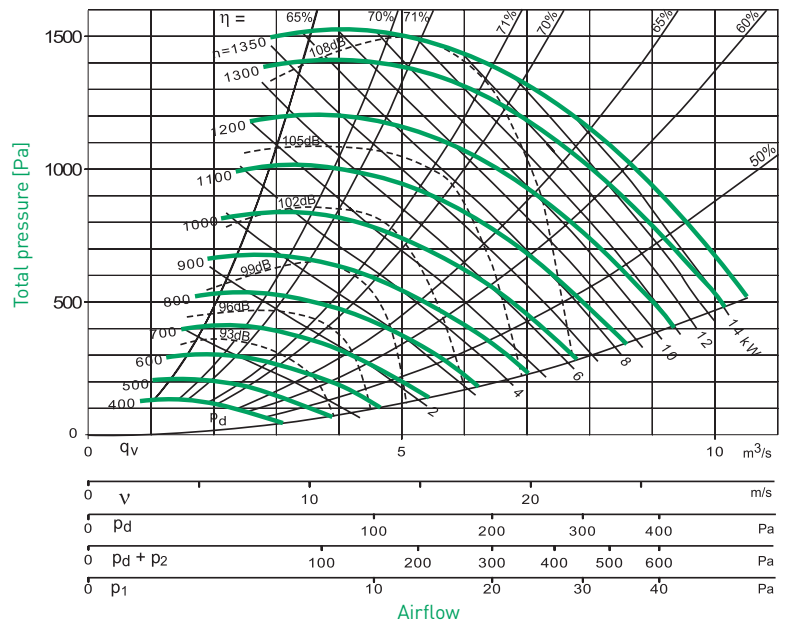

### BASIS FOR CHART

(Arr. D)

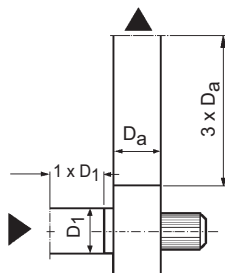

### SYMBOLS

- |       |                            |        |                             |
|-------|----------------------------|--------|-----------------------------|
| $p_t$ | = total pressure           | $q_v$  | = airflow                   |
| $p_d$ | = dynamic pressure, outlet | $n$    | = RPM                       |
| $p_1$ | = connection loss, inlet   | $\eta$ | = efficiency in %           |
| $p_2$ | = connection loss, outlet  | $kW$   | = power demand, impeller    |
| $v$   | = air speed, outlet        | $dB$   | = sound power level, outlet |



**CNA 800**

max. = 975 RPM  
 $\rho = 1.20 \text{ kg/m}^3$   
 $I_v = 5 \text{ kgm}^2$

**CNB 800**

max. = 1190 RPM  
 $\rho = 1.20 \text{ kg/m}^3$   
 $I_v = 5 \text{ kgm}^2$

**CIRCUMFERENTIAL SPEED**

$u = 0.042 \times n, \text{ m/s}$

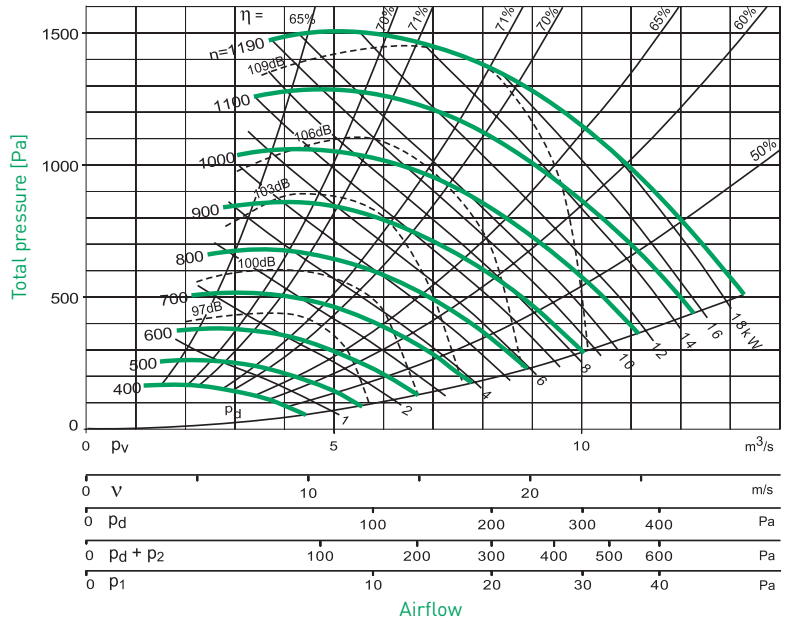

**CNA 900**

max. = 870 RPM  
 $\rho = 1.20 \text{ kg/m}^3$   
 $I_v = 7.75 \text{ kgm}^2$

**CNB 900**

max. = 1065 RPM  
 $\rho = 1.20 \text{ kg/m}^3$   
 $I_v = 7.75 \text{ kgm}^2$

**CIRCUMFERENTIAL SPEED**

$u = 0.047 \times n, \text{ m/s}$

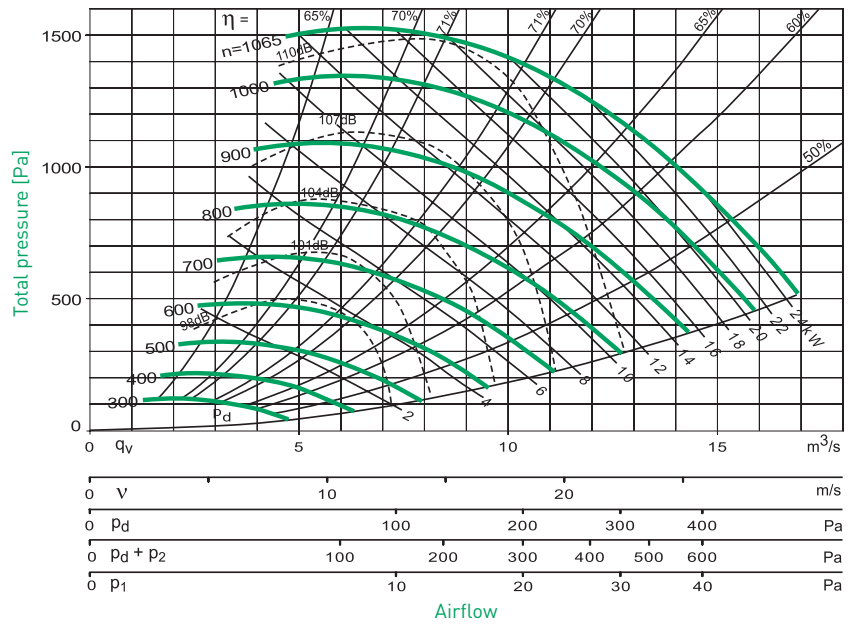

**BASIS FOR CHART**

(Arr. D)

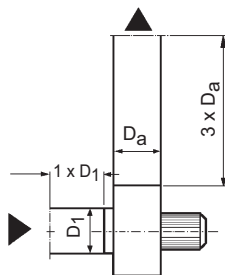

**SYMBOLS**

- |       |                            |        |                             |
|-------|----------------------------|--------|-----------------------------|
| $p_t$ | = total pressure           | $q_v$  | = airflow                   |
| $p_d$ | = dynamic pressure, outlet | $n$    | = RPM                       |
| $p_1$ | = connection loss, inlet   | $\eta$ | = efficiency in %           |
| $p_2$ | = connection loss, outlet  | $kW$   | = power demand, impeller    |
| $v$   | = air speed, outlet        | $dB$   | = sound power level, outlet |

### CNA 1000

max. = 785 RPM  
 $\rho = 1.20 \text{ kg/m}^3$   
 $I_v = 14 \text{ kgm}^2$

### CNB 1000

max. = 960 RPM  
 $\rho = 1.20 \text{ kg/m}^3$   
 $I_v = 14 \text{ kgm}^2$

### CIRCUMFERENTIAL SPEED

$u = 0.052 \times n, \text{ m/s}$

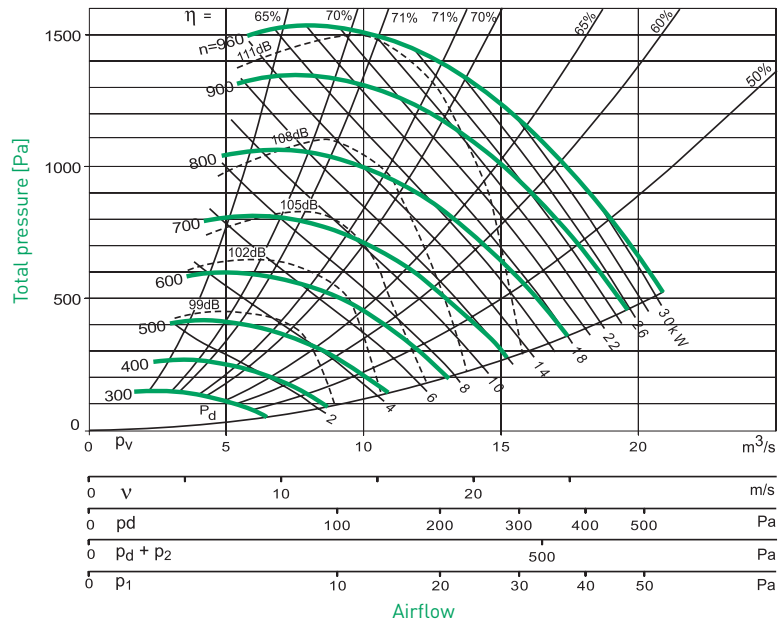

### BASIS FOR CHART

(Arr. D)

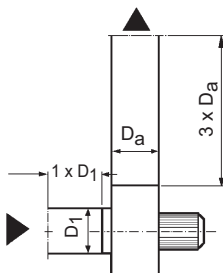

### SYMBOLS

$p_t$	= total pressure	$q_v$	= airflow
$p_d$	= dynamic pressure, outlet	$n$	= RPM
$p_1$	= connection loss, inlet	$\eta$	= efficiency in %
$p_2$	= connection loss, outlet	kW	= power demand, impeller
$v$	= air speed, outlet	dB	= sound power level, outlet

# DIMENSIONS

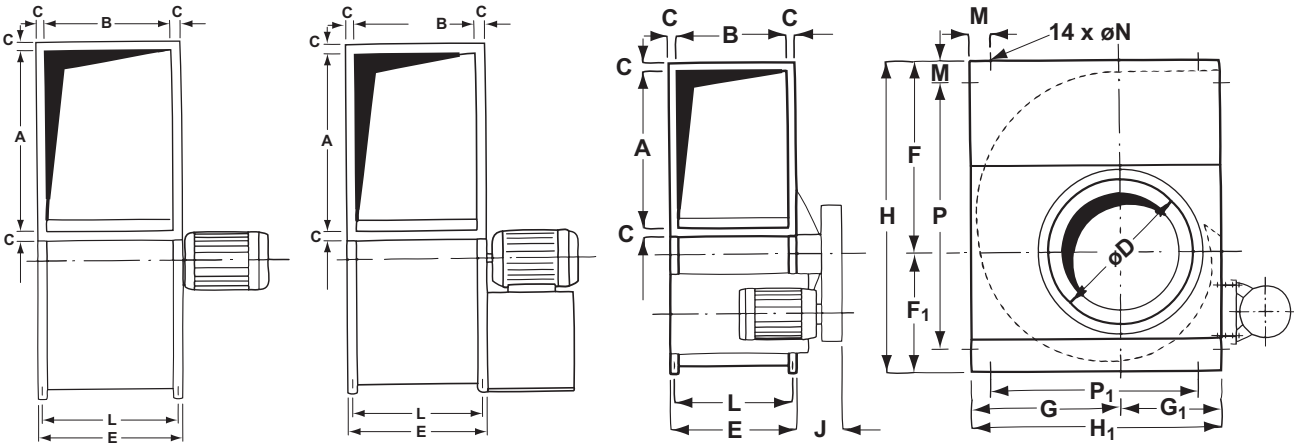

**Direct driven**  
CNA 250, -315, -400  
CNB 400

CNA 500, -630  
CNB 500, -630

**Belt-driven**  
all sizes

CNA CNB	DIMENSIONS [mm]																	Weight <sup>1</sup> [kg]	
	A	B	C	D	E	F	F <sub>1</sub>	G	G <sub>1</sub>	H	H <sub>1</sub>	J	L	M	N	P	P <sub>1</sub>	CNA	CNB
-250	250	175	30	250	235	310	250	245	200	560	445	150	207	60	12	440	325	22	-
-315	315	220	30	315	280	410	280	345	250	690	595	160	252	100	12	490	395	35	-
-400	400	280	30	400	340	485	315	400	300	800	700	145	312	100	12	600	500	53	55
-500	500	350	35	500	420	600	400	500	350	1000	850	170	392	125	15	750	600	89	98
-630	630	440	35	630	510	758	488	623	440	1246	1063	250	482	125	15	996	813	146	161
-710	710	497	40	710	577	870	535	670	465	1405	1135	260	537	62.5	15	1280	1010	238	262
-800	800	560	40	800	640	976	604	754	516	1580	1270	280	600	85	15	1410	1100	304	334
-900	900	630	45	900	720	1098	680	847	573	1778	1420	300	680	110	15	1558	1200	350	385
-1000	1000	700	45	1000	790	1215	750	940	640	1965	1580	360	750	90	15	1785	1400	487	535

1. Weights excl. motors and belt drive

## OUTLET FLANGES

CNA CNB	P	R	S	T
-250	207	85	282	110
-315	252	110	347	142.5
-400	312	140	432	185
-500	386	125	536	155
-630	476	170	666	200
-710	537	150	750	170
-800	600	170	840	175
-900	680	195	950	200
-1000	750	160	1050	180

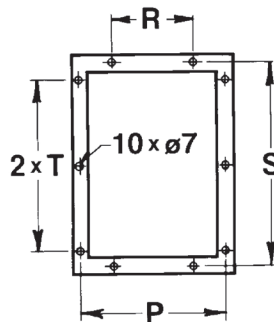

Sizes -250, -315, -400

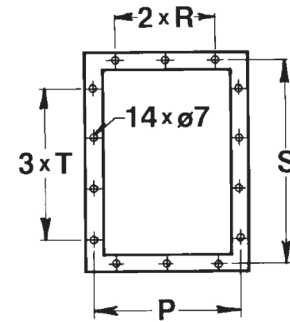

Sizes -500, -630

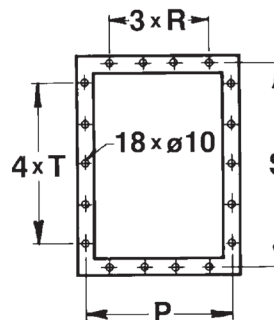

Sizes -710, -800, -900

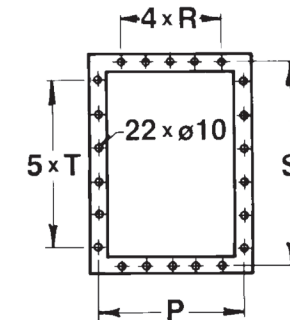

Size -1000

**Counter flanges** (4 rails) with the same bolt holes as the outlet flanges are available as accessories.

**Ducts** are made with the same internal dimensions as the fan outlet opening (A x B).

See dimensions above.

# POSITION DESIGNATIONS

Fan positions in connection with installation on a common base frame must be indicated in accordance with Eurovent.

## DIRECT DRIVEN

Motor installed on fan housing

Position RD 0

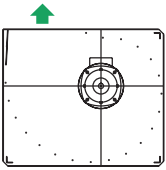

Position RD 90

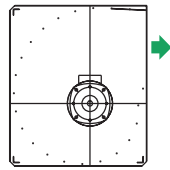

Position RD 180

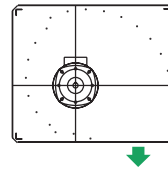

Position RD 270

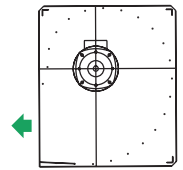

Position LG 0

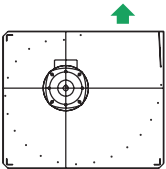

Position LG 90

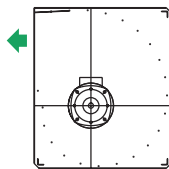

Position LG 180

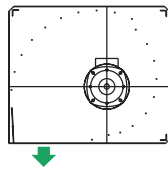

Position LG 270

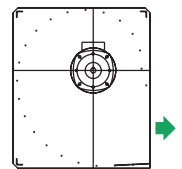

## BELT-DRIVEN

Low motor bracket for belt drive

Position LG/1

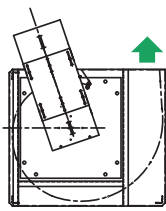

Position LG/2

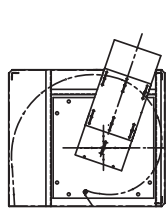

Position LG/3

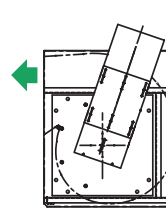

Position LG/4

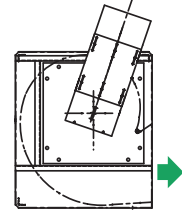

Position RD/1

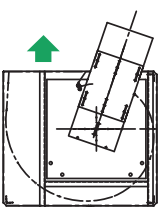

Position RD/2

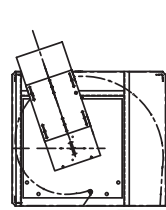

Position RD/3

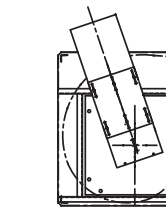

Position RD/4

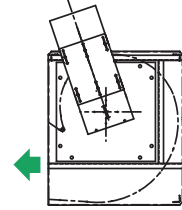

Positions in accordance with Eurovent seen from the motor side

# MOTORS

## Installation

The tables show the maximum motor size that can be installed directly on the fan.

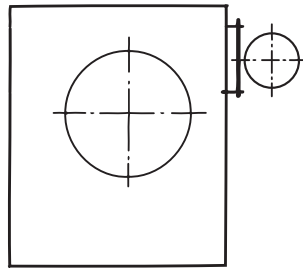

Motor on the side  
- vertical motor panel

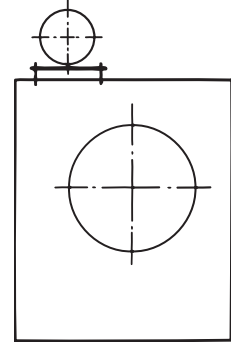

Motor on the top  
- horizontal motor panel

## MOTOR SIZES

### DIRECT DRIVEN

FAN SIZE	MOTOR INSTALLATION SIZE
CNA 250	71-90
CNA 315	71-100
CNA/B 400	80-100
CNA/B 500	112-132
CNA 630	132
CNB 630	160

250-400 Design B14 small  
500-630 Design B3

### BELT-DRIVEN

CNA CNB	MAX. MOTOR	
	TYPE	WEIGHT (kg)
-250	90	20
-315	112	40
-400	112	40
-500	132	70
-630	132	70
-710	132	70
-800	132	70
-900	132	70
-1000	132	70

### BELT-DRIVEN

CNA CNB	MAX. MOTOR	
	TYPE	WEIGHT (kg)
-250	90	20
-315	112	40
-400	112	40
-500	132	70
-630	132	70
-710	160	140
-800	160	140
-900	180 <sup>1</sup>	190
-1000	180	190

1. CNA max. 160

## Base frame for fan and motor

Large motors are installed on clamp rails beside the fan. A common base frame for the fan and motor, as shown in the drawings, is available. Please state the desired motor position (pos. W or Z).

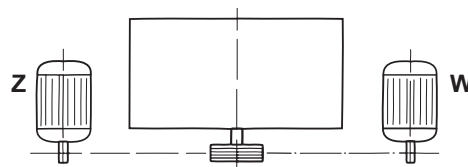
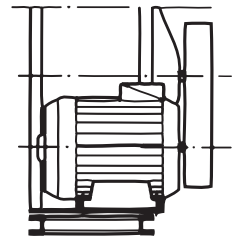
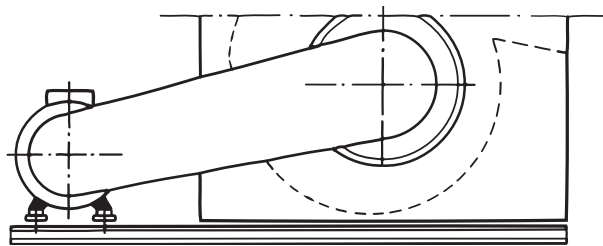

## SHAFT END FOR BELT DRIVE

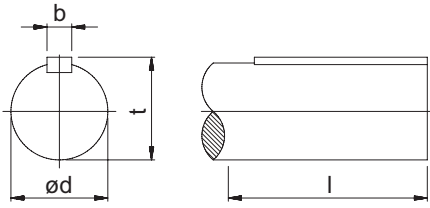

CNA	d	l	b	t
-250	24j6	50	8	27
-315	24j6	50	8	27
-400	24j6	50	8	27
-500	28j6	50	8	31
-630	32k6	60	10	35
-710	35h8	100	10	38
-800	40h8	100	12	43
-900	40h8	100	12	43
-1000	55h8	100	16	59

CNB	d	l	b	t
-250	-	-	-	-
-315	-	-	-	-
-400	28jk	50	8	31
-500	38k6	90	10	41
-630	48k6	90	14	51.5
-710	55m6	100	16	59
-800	55m6	100	16	59
-900	60m6	115	18	64
-1000	60m6	115	18	64

## ACCESSORIES

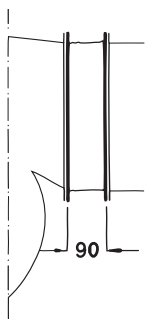

Flexible connection, outlet

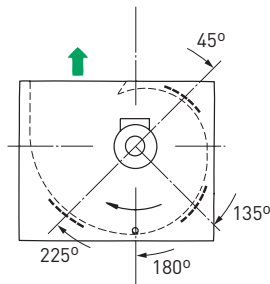

Drain plug Inspection hatch

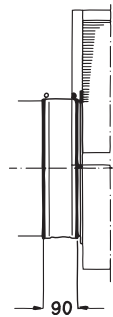

Flexible connection, inlet

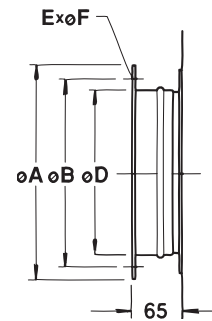

Duct spigot

CNA	A	B	D	E	F
-250	310	280	250	4	10
-315	385	355	315	8	10
-400	480	450	400	8	12
-500	590	560	500	12	12
-630	720	690	630	12	12
-710	790	765	710	10	14
-800	880	850	800	10	14
-900	1000	970	900	16	14
-1000	1080	1050	1000	16	14

Type CNA and CNB are available with inspection hatches in the fan housing and with drain bosses.

### Example:

Inspection hatch pos. RD 135  
Drain plug pos. RD 180

The hatches can be placed at angles of 45°, 135° or 225° from the outlet. The drain plug must always be at the lowest point in the housing.

Hatches are available for both types and sizes 250-630. Refer to the AirBox software for configuration.

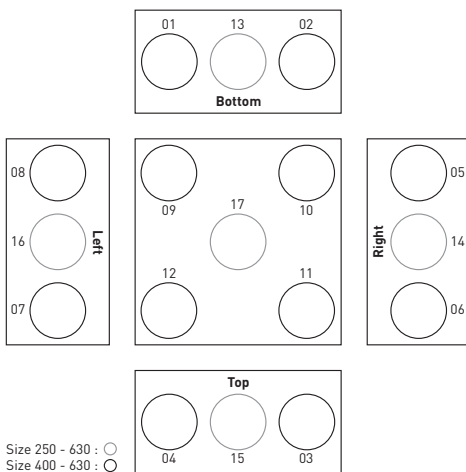

Size 250 - 630 : ○  
Size 400 - 630 : ○

Suction box

The suction box fits on the fan outlet and allows for universal connection to an existing duct system.

The positions and specifications of the duct connections are specified with the AirBox program



# SOUND CONDITIONS

When a fan is operated, sound is generated. This is partly electrical and mechanical sound in the motor, bearings and other mechanical parts, partly air sound that occurs as the air flows through the fan.

Sound generation is counteracted by the correct design and careful production of fan parts, in particular the inlet cone and impeller, where air sound is concerned. In this connection, it must be noted that poor installation conditions, for example a sharp duct bend immediately before the inlet opening, may increase sound generation considerably.

The electrical and mechanical sound, and that part of the air sound that passes out through the fan housing, can only be dampened by surrounding the fan with a casing or walls of low-vibration (heavy) materials.

The sound generated in the impeller is distributed through the inlet and outlet openings to the duct system and on to the ventilated rooms.

Calculation of the sound conditions in the duct system and the ventilated rooms, including dimensioning of any

silencers in the system, is only possible on the basis of the sound power level in the fan inlet and outlet openings.

In connection with all considerations concerning sound, a sharp distinction must be made between the terms sound power level and sound pressure level.

The *sound power level* is an expression of the sound energy emitted through the fan inlet and outlet openings and forms the basis for any calculation concerning the sound conditions in the connected duct systems and in the rooms served by the fan.

The *sound pressure level* (often just called the sound level) is a measure of the sound impression perceived by the ear at a given location in the fan surroundings. It is measured using a sound meter with a microphone mounted in a specific location.

The sound pressure level depends on the fan sound power level, the distance from the fan and the silencing properties of the surroundings. When the fan sound properties are characterised

by stating a sound pressure level, it is therefore necessary also to give a precise description of the conditions under which the sound level stated occurs.

When comparing the sound properties of two fans, the sound power level must never be compared with the sound pressure level, and it is only possible to compare two sound pressure levels when the distance from the fan and the silencing in the surroundings are identical.

For a correctly constructed fan, the sound power level depends mainly on the airflow rate supplied and the total fan pressure.

The sound power level of the individual fans is shown in the graphs on pages 9-13 and is stated in dB with a reference value of  $10^{-12}$  W and applies within the normal fan working range with a tolerance of  $\pm 5$  dB. If the sound power level needs to be divided into octave values, the sound power level in the different octave bands is determined by deducting the correction values in the table from the total sound power level found.

For CNA and CNB, the correction values depend on the blade frequency.

$$z \times \frac{n}{60}, \text{ where}$$

$z$  = number of blades and  
 $n$  = fan speed in RPM.

For CNA and CNB the number of blades is 12.

## CORRECTION VALUES

	Blade frequency [Hz]	Octave band [Hz]						
		63	125	500	1k	2k	4k	8k
Correction value	90-180	7	4	12	17	22	27	32
	180-360	11	7	7	12	17	22	27
	360-710	13	11	4	7	12	17	22
	710-1400	15	13	6	4	7	12	18

**Example:** A centrifugal fan type CNA 315 has an output of 0.6 m<sup>3</sup>/s at 300 Pa and 1400 RPM.

Blade frequency:  $12 \times 1400/60 = 280$  Hz.

As the graph on page 10 shows, the total sound power level is 84 dB.

The correction value for 250 Hz is 4 dB.

The sound power level for this octave band is thus: 84 dB – 4 dB = 80 dB

The full octave analysis is shown in the table below.

	Octave band [Hz]						
	63	125	500	1k	2k	4k	8k
Sound power level [dB]	73	77	77	72	67	62	57

# REGULATION OF AIRFLOW RATE

Depending on the operating requirements, the fan capacity can be regulated in several ways.

- Changing poles between 2 fixed RPMs in the ratio 3:2 (motor with 2 separate windings) or 2:1 (Dahlander winding motor)
- Frequency regulation
- A combination of the above

## CHANGING POLES

In connection with time-related variations in the airflow rate demand (for example, night-time and daytime operation), it is recommended that the fan be fitted with a change-pole motor. When the fan is changed to a different RPM, the fan efficiency is unchanged. The change can be controlled by a timer. If other operating points are required than can be achieved by changing poles, other regulation methods must be used.

## FREQUENCY REGULATION

The fan efficiency remains virtually unchanged throughout the regulation range and no sound is generated during the regulation.

# QUALITY AND SERVICE



## REST ASSURED

The Novenco CNA-CNB centrifugal fans are produced in accordance with Novenco's well-known quality standards. Novenco Building & Industry A/S is ISO certified and all fans are inspected and tested.

The fans are offered with options for technical guidance on installation, test of function and training of personnel.

## WARRANTY

Novenco provides according to law a standard 12 months warranty from the

product is sent from the factory. The warranty covers materials and manufacturing defects. Wear parts are not covered.

Extended warranty can be agreed upon.

## IMPORTANT

This document is provided 'as is'. Novenco Building & Industry A/S reserves the right to changes without further notice due to continuous product development.

Some pictures in the catalogue show products with accessories fitted.

The fans are designed for continuous operation. The following kinds of operation may cause fatigue break in the impellers and endanger people.

- Operation in stall area
- Operation with pulsating counter pressure – called pump mode
- Operation with exceedingly starts and steps

If in doubt, Novenco should be contacted to assess the suitability of the fans.

Copyright (c) 1998 - 2017,  
Novenco Building & Industry A/S.  
All rights are reserved.

## PATENTS AND TRADEMARKS

Novenco®, ZerAx®, 诺文科, 诺万科 and are 诺克  
NOVENCO registered trademarks of Novenco A/S.

AirBox™ and NovAx™ are trademarks of  
Novenco Building & Industry A/S.

Other trademarks appearing in this document  
are the property of their respective owners.

## QUALITY AND ENVIRONMENT

Novenco Building & Industry A/S is certified in  
accordance with ISO 9001 and 14001.



All Novenco Building & Industry's products are  
designed, developed and manufactured in  
Denmark.

